

# Wardrobe – Single

## Assembly Instructions

- Take great care handling and lifting parcels
- Open parcels with care to avoid damage
- Check the label to see the contents of each parcel
- If you have ordered several items, keep it simple: only unpack one item at a time
- Use the the Parts Diagram sheet to identify and distinguish between parts
- Any questions: call us on **01227 833333**, or email **sales@jali.co.uk**

### YOU WILL NEED

---

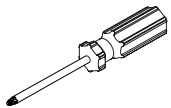

5mm Pozi  
Screwdriver

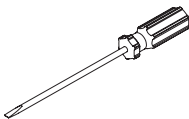

Long Flat  
Head



Power  
Drill

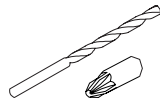

2mm Drill  
& Pozi Drive

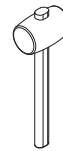

Mallet

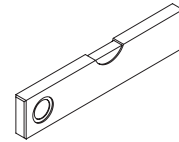

Spirit  
Level

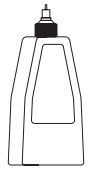

Wood  
Glue

### NOTES

---

- You must fix your product safely in place. Once level, you may wish to screw the base to the floor
- To ensure a perfect fit with your room skirting board, you may wish to scribe (cut with a saw) the relevant parts during assembly

### FIXINGS MAY VARY ACCORDING TO YOUR DESIGN

---

Plus Door Handles with Bolts as required

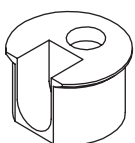

White Cam

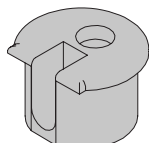

Nickel Cam

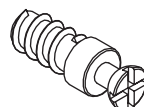

Cam Bolt

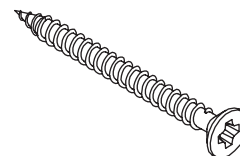

45mm CSK  
Screw

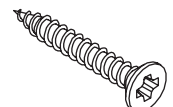

20mm CSK  
Screw

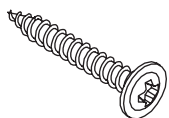

**25mm WSH Screw**

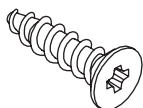

**17mm CSK Screw**

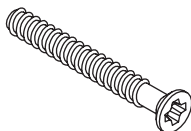

**Confirmat Screw**



**Button**

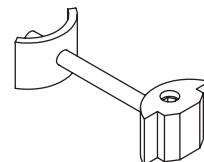

**Connector**



**Door Buffer**

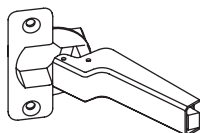

**Hinge**

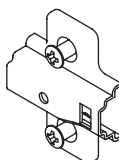

**Hinge Plate**

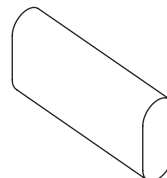

**Hanging Rail**



**Rail Bracket**

## SEE HOW IT COMES TOGETHER

1. Start by identifying the parts. Your design may be different to this example, but don't worry; it will become clearer as we work through.

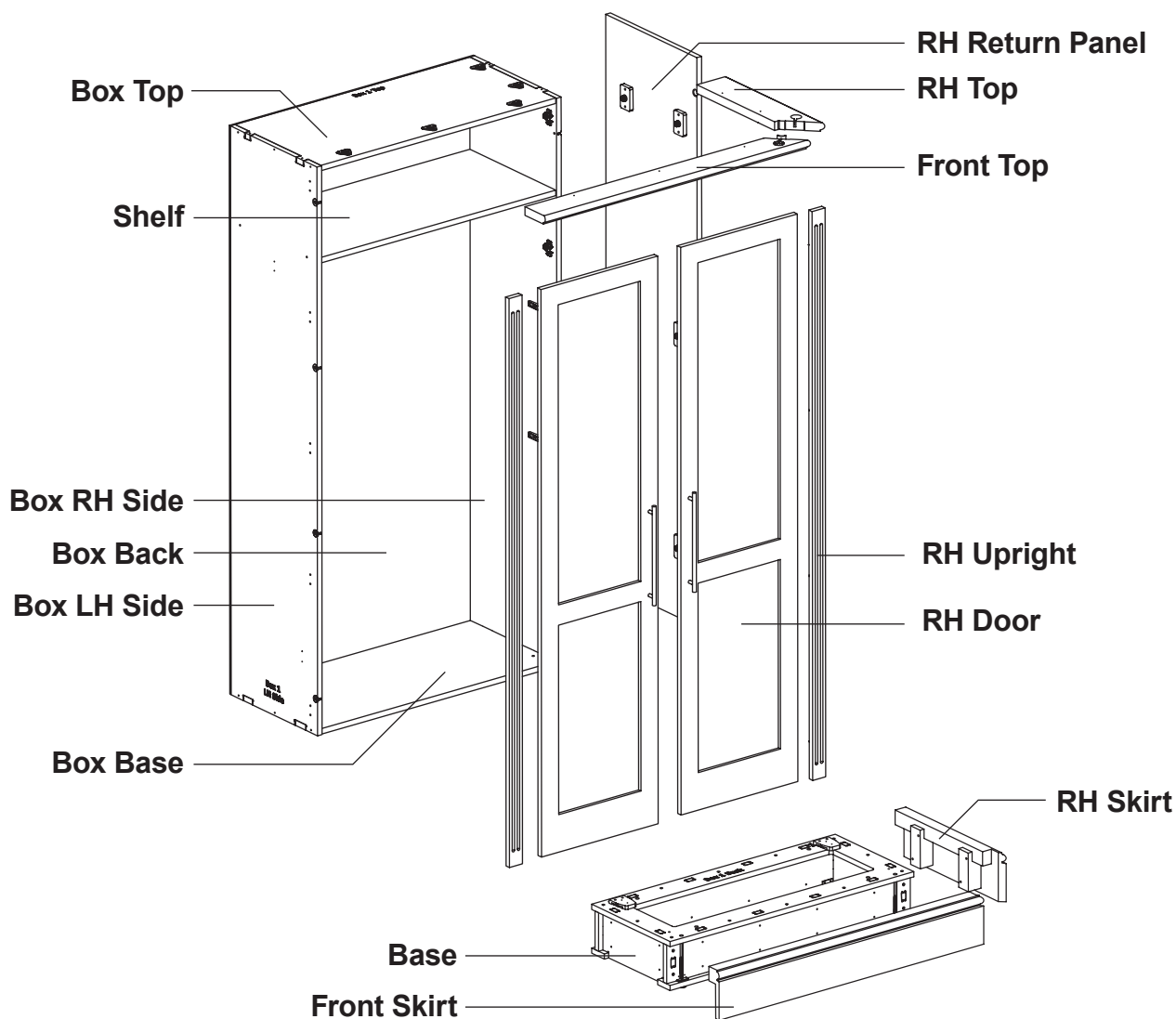

## PLACE FIXINGS

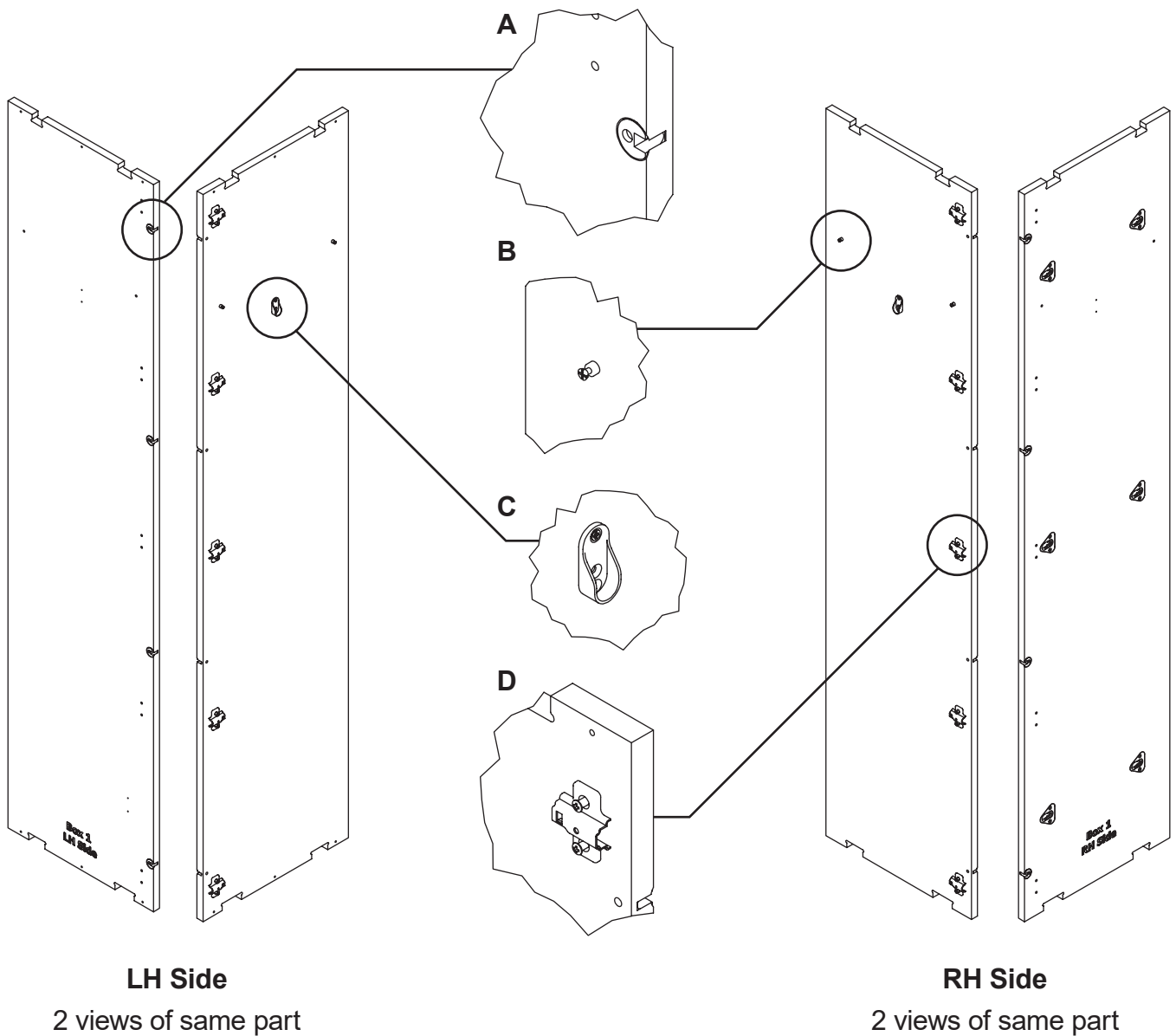

2. We'll start with the left hand (LH) and right hand (RH) Sides. **A.** Place White Cams in all the available holes, facing outwards. **B.** If your design features Shelves, using the screwdriver (or a power tool on a low setting) screw the Cam Bolts into the available 5mm holes on the inner face. **C.** If your design features a Hanging Rail, screw the Rail Bracket in place with 17mm CSK Screws.

3. **D.** If your design features Doors, screw the Hinge Plates into place with the square hole toward the back.

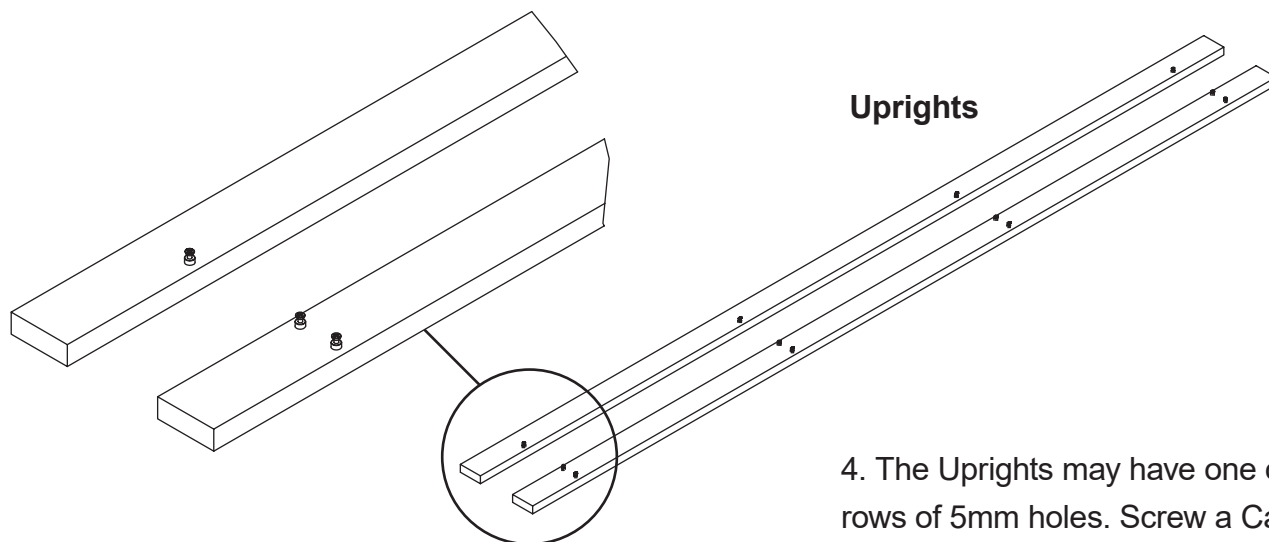

**Uprights**

4. The Uprights may have one or two rows of 5mm holes. Screw a Cam Bolt into each available hole.

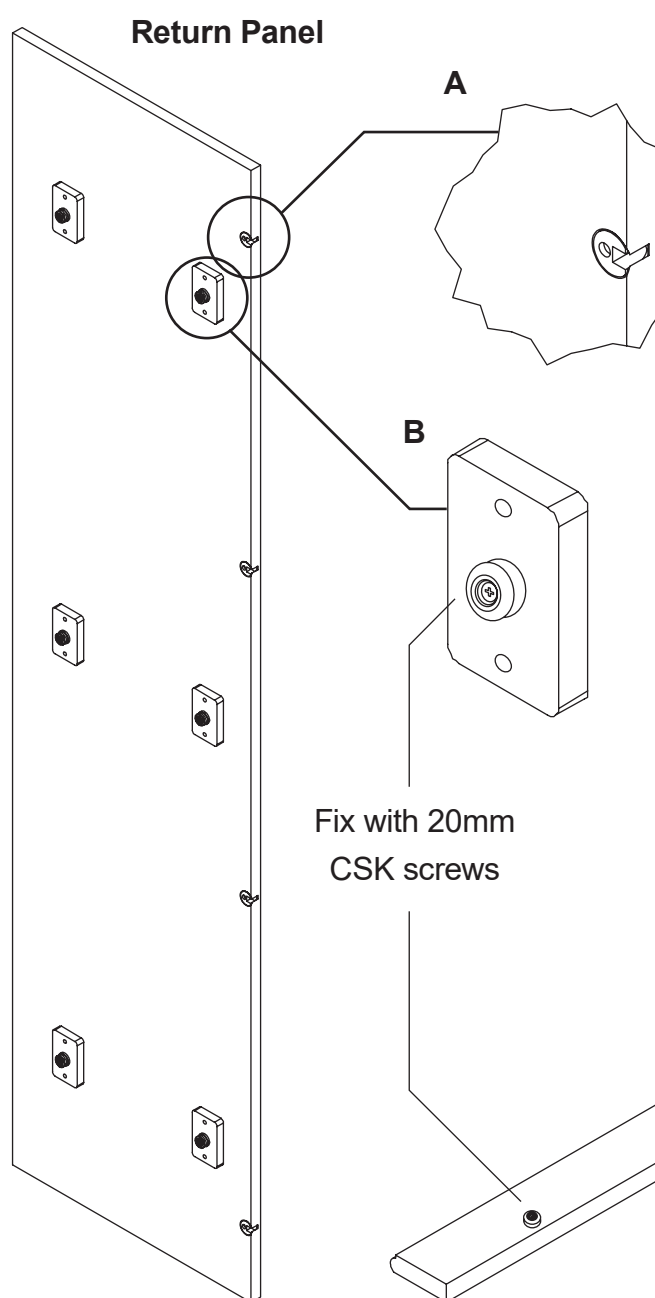

**Return Panel**

**A**

**B**

Fix with 20mm  
CSK screws

5. Return Panels attach to any free standing sides, i.e. sides not intended to be fitted against a wall. **A.** Place White Cams in all the available holes, facing outwards. **B.** Fix Buttons onto each of the blocks with 20mm CSK Screws.

6. The Top may be solid, or formed of several parts in which case the topside features large circular holes (for the Connector). We're going to attach Buttons to the the 1mm holes on the underside. Fix the Buttons in place with 20mm CSK Screws.

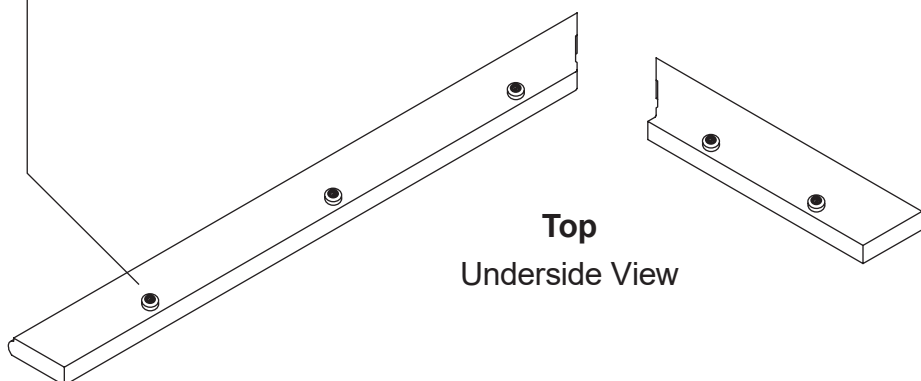

**Top**  
Underside View

7. If your design features Shelves, place the Nickel Cams into each of the available holes, facing outwards. These Cams are supposed to sit slightly proud of the Shelf.

8. If your design features Dividers – vertical pieces within a Box – place Nickel Cams in them as necessary. These cams correspond to Cam Bolts which may need fixing to a Box Top, Box Base, or specific Shelves. Fix Cam Bolts to the underside of Box Tops and the topside of Box Bases. Refer to the Parts Diagram to ensure you fix the Cam Bolts to the correct side of the Shelves, which may be the topside or underside.

9. Hinges can be fixed into the circular recesses on each Door with 17mm CSK Screws.

The latest Hinge model features a cover that may need to be clicked open (gently use a screwdriver) to access the screw holes. Once screwed onto the door, click the cover fully down into place to hide the screws.

Press the Door Buffers into place at the top and bottom of each Door.

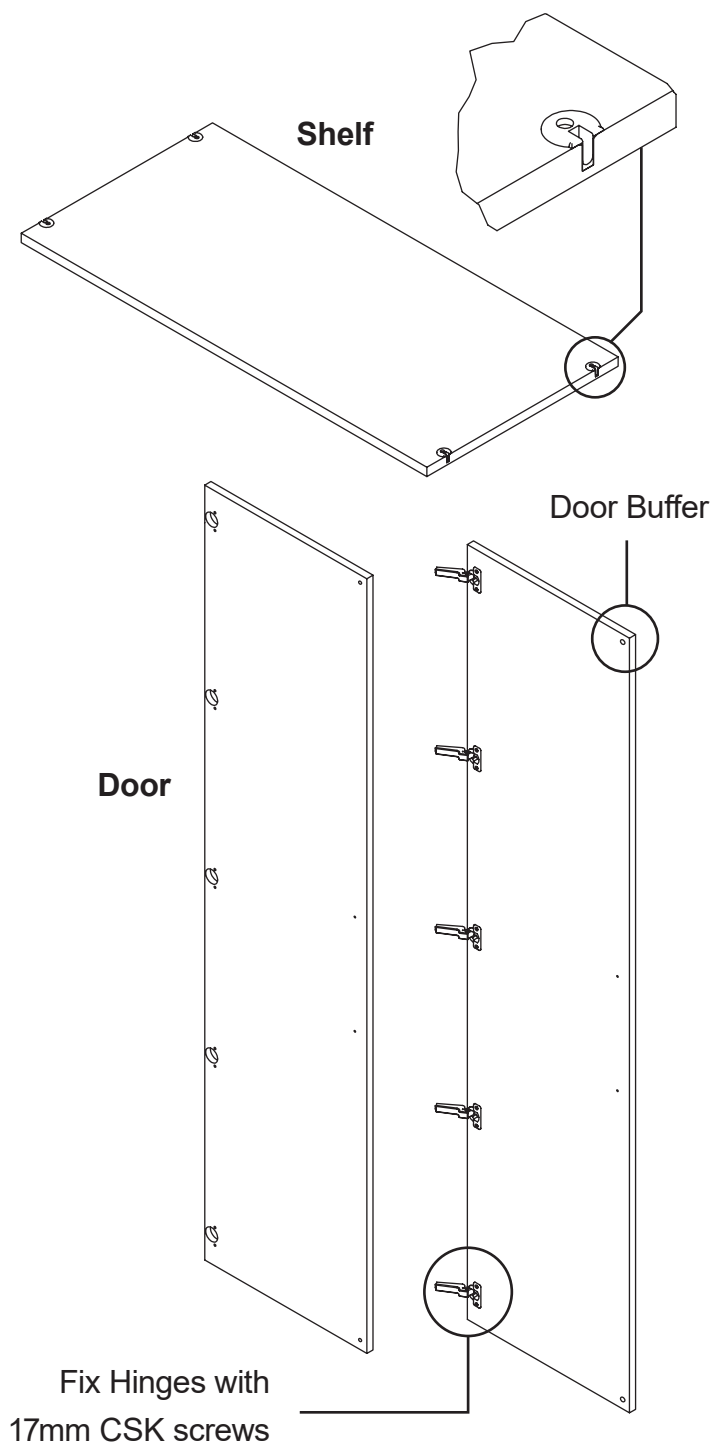

## HOW DO CAM & BOLTS WORK?

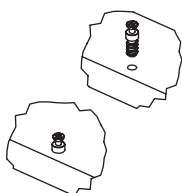

1. Screw in the Cam Bolt, up to the shoulder, into the 5mm hole in one part.

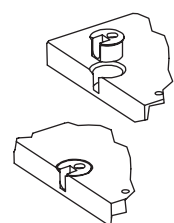

2. Push the Cam, facing outwards, into the corresponding hole on the other part.

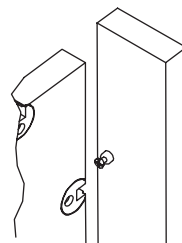

3. Push the two parts together, so that the Cam Bolts disappear into the middle of the Cams.

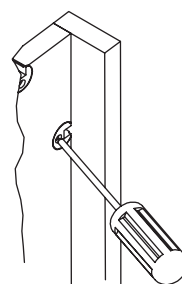

4. Insert a 5mm Pozi screwdriver – tilt back at a slight angle – and rotate CW to lock the Cam.

## BUILD THE Box

10. Assemble the Box with the front edge facing the floor. Engage the LH Side and Box Base, and use a mallet to gently knock them together. Once fully home, pilot drill 2mm holes through the Box Base tenon holes into the LH Side, then fix together with 45mm CSK Screws.

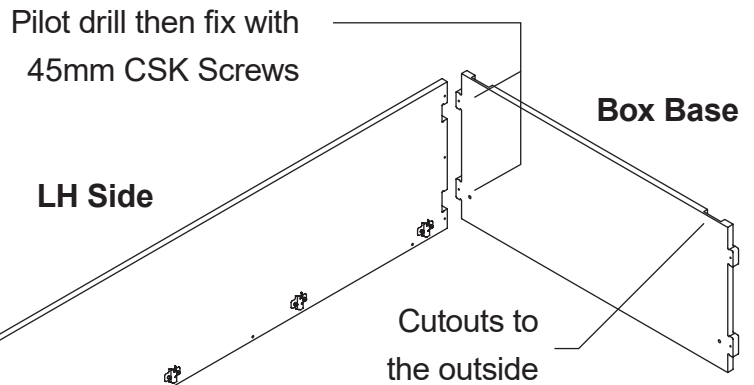

11. Attach the RH Side and the Box Top to the assembly. Carefully mallet into place, pilot drill and fix together with 45mm CSK Screws.

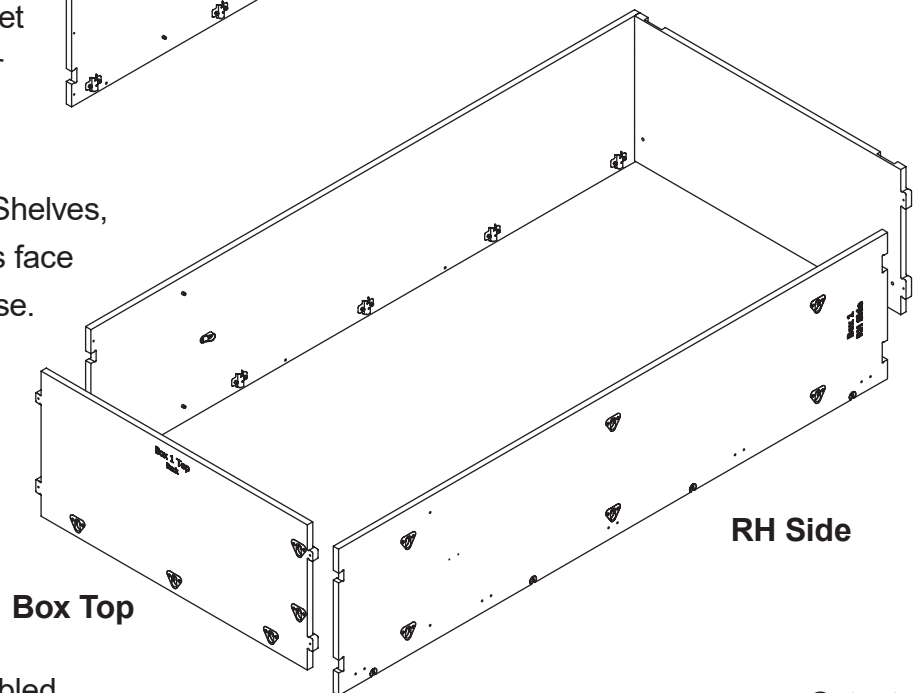

12. If the Box design includes any Shelves, fit these next. Ensure that the cams face downwards, i.e. toward the Box Base.

13. This example doesn't feature any Dividers. However, you can fit any Dividers next by positioning them in the appropriate Box and locking the cams into place.

14. Place the Back onto the assembled Box, with the engraved label towards the top, and facing up/outwards, as shown. Slide the Back over until its top edge aligns perfectly with the top edge of the Box Base. Once in place, screw along the bottom edge with 25mm WSH Screws, through the 3mm holes. Now fix down one side, accurately realigning the Back edge to the Side as you go. Effectively you are using the Back to square up the Box. Once this is done you can screw in all the remaining 25mm WSH Screws, securing it in place.

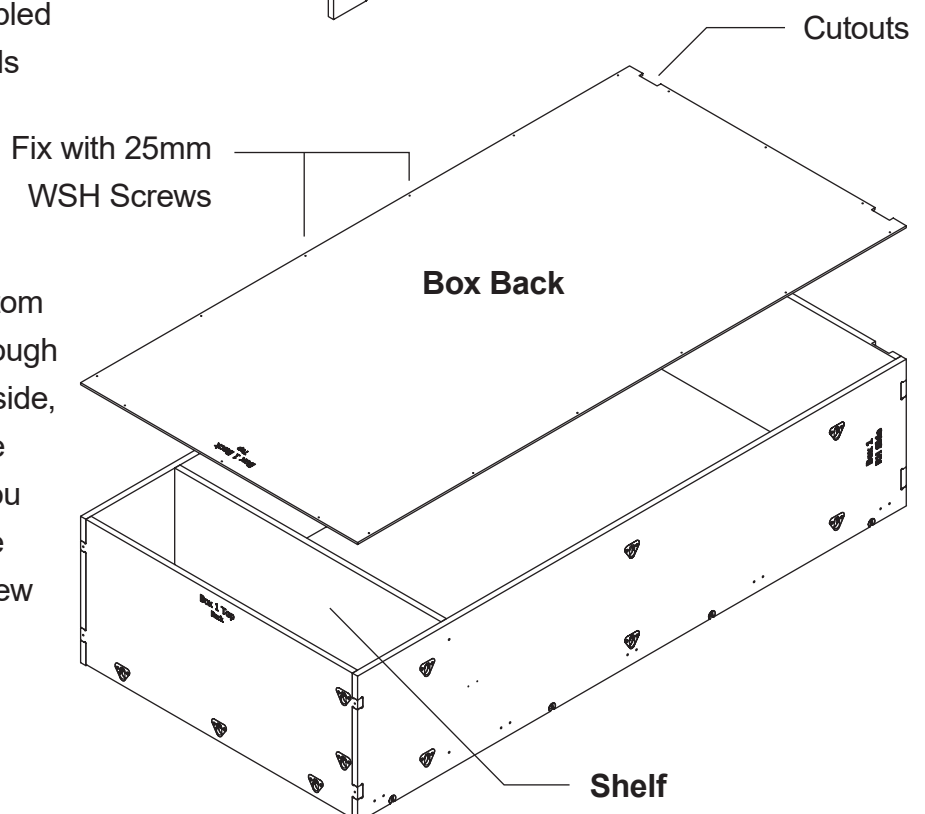

## PREPARE THE BASE

---

If you wish to scribe the Skirts to fit around the existing room skirting board, do this now. For help with this, please get in touch.

15. Position the Base the correct distance from the back and side walls. This will depend on how you designed any clearances; 'trial fit' the Skirts to the Base to check. Once positioned, level the Base by turning the adjustable feet with a long flat head screwdriver. Place a spirit level across the Base to get an accurate result. When the Base is level, you may wish to secure it by screwing it to the floor.

16. The Skirts can now be screwed (from the inside) or glued to the Base with normal wood glue. Apply glue evenly to the Skirts and press them firmly into place, ensuring that any gaps between the mitred edges disappear.

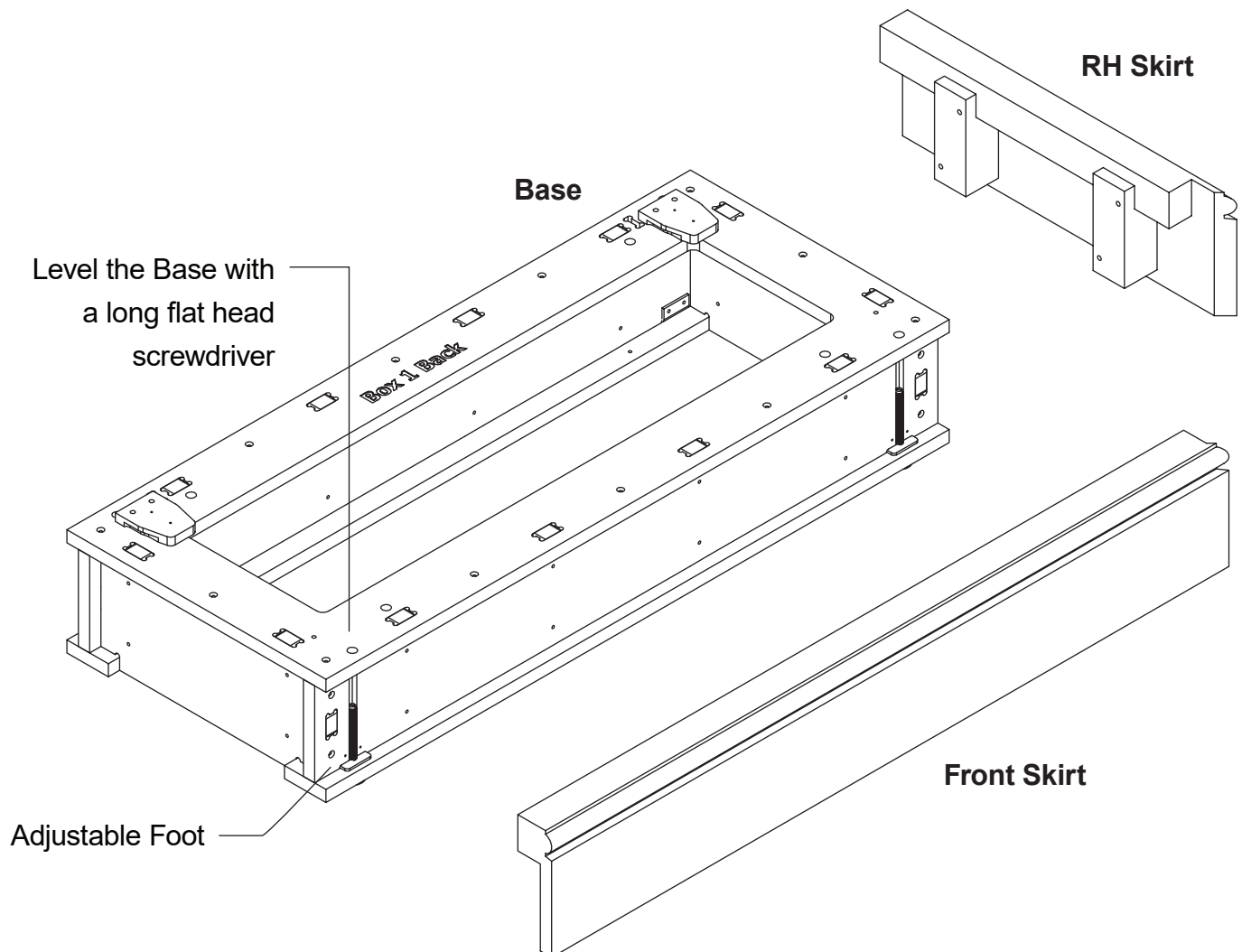

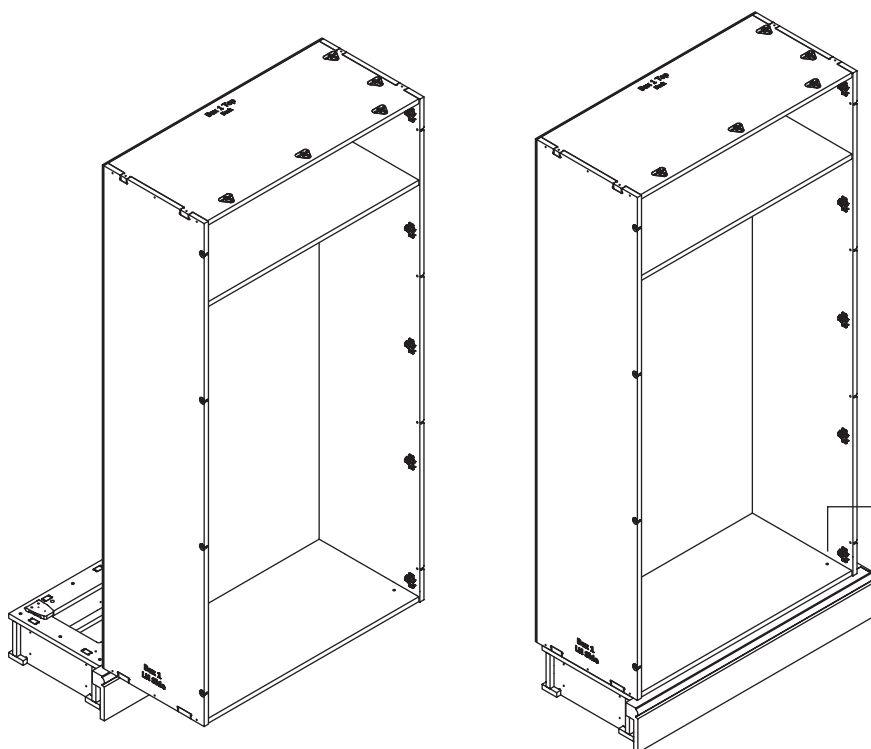

17. Carefully lift up the Box and place onto the Base. You may need to enlist some help to do this safely. Slide the Box backwards until it has fully engaged. Now you can fix the Box to the Base using Confirmat Screws through the provided holes.

Fix with Confirmat Screws

**RH Return Panel  
+ RH Upright**

If your Wardrobe is 'free standing', you will have a Return Panel on both sides. If it is fitted between two walls, you will have no Return Panels. In this example, there is a RH Return Panel but no LH Return Panel, because the unit is intended to fit against a LH side wall. **Follow this example to work out how to apply the same rules to your own design, depending on which sides are intended to be fitted.**

18. The LH Upright has only one row of Cam Bolts, and can be attached directly to the LH Side by fastening the Cams.

19. The RH Upright has two rows of Cam Bolts, and should first be attached to the RH Return Panel as shown, using the Cams.

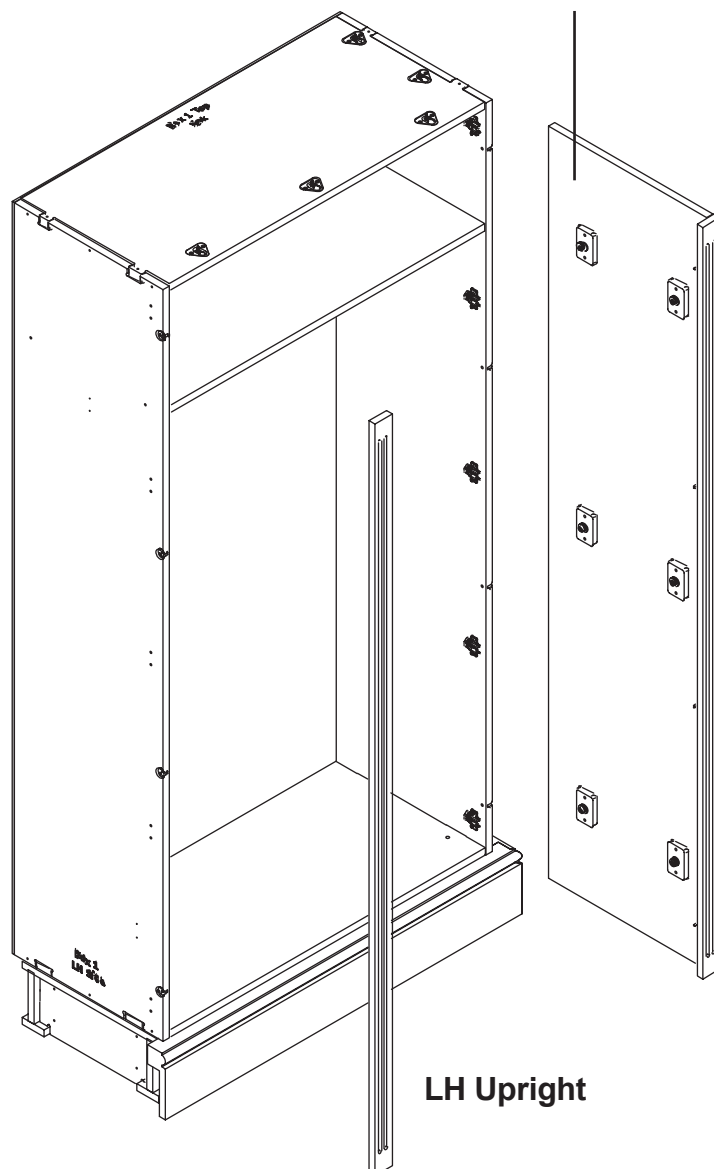

**LH Upright**



To fix the RH Return Panel to the Box, line up and engage the Buttons with the triangular fittings on the RH Side. Push them home by sliding the RH Return Panel towards the back of the unit. The RH Upright should now be flush with the front of the Box.

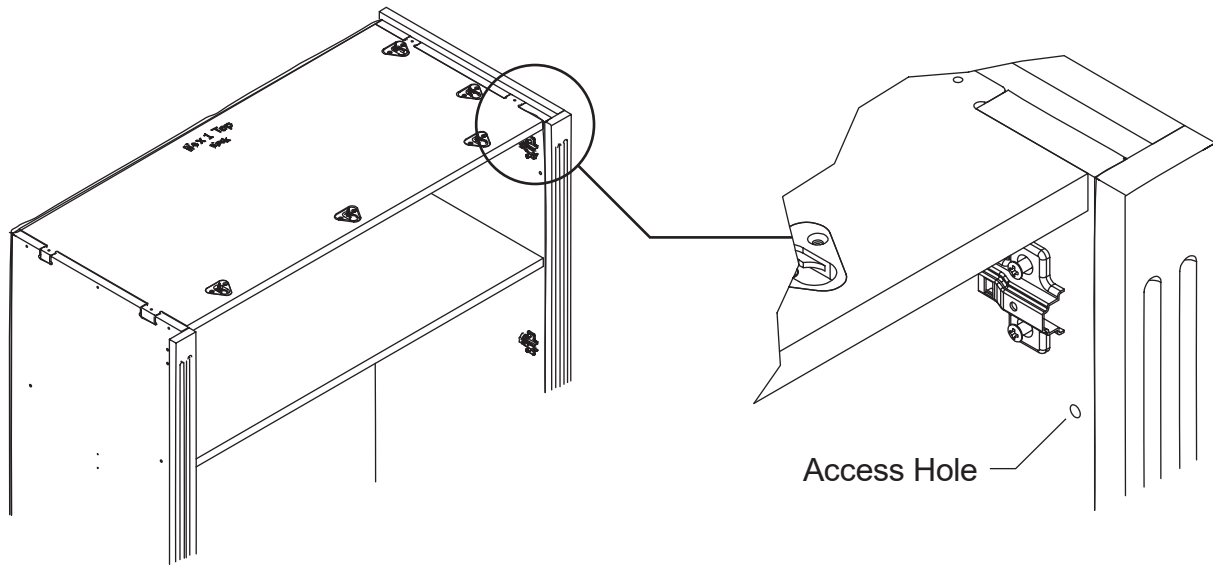

The remaining row of Cams must now be fastened, connecting the RH Side to the RH Upright. These can be accessed via the holes on the RH Side. Insert the 5mm Pozi screwdriver and engage it with each Cam, turning clockwise to lock the Upright into place. Since this must be done 'blind', it can take a knack to get right.

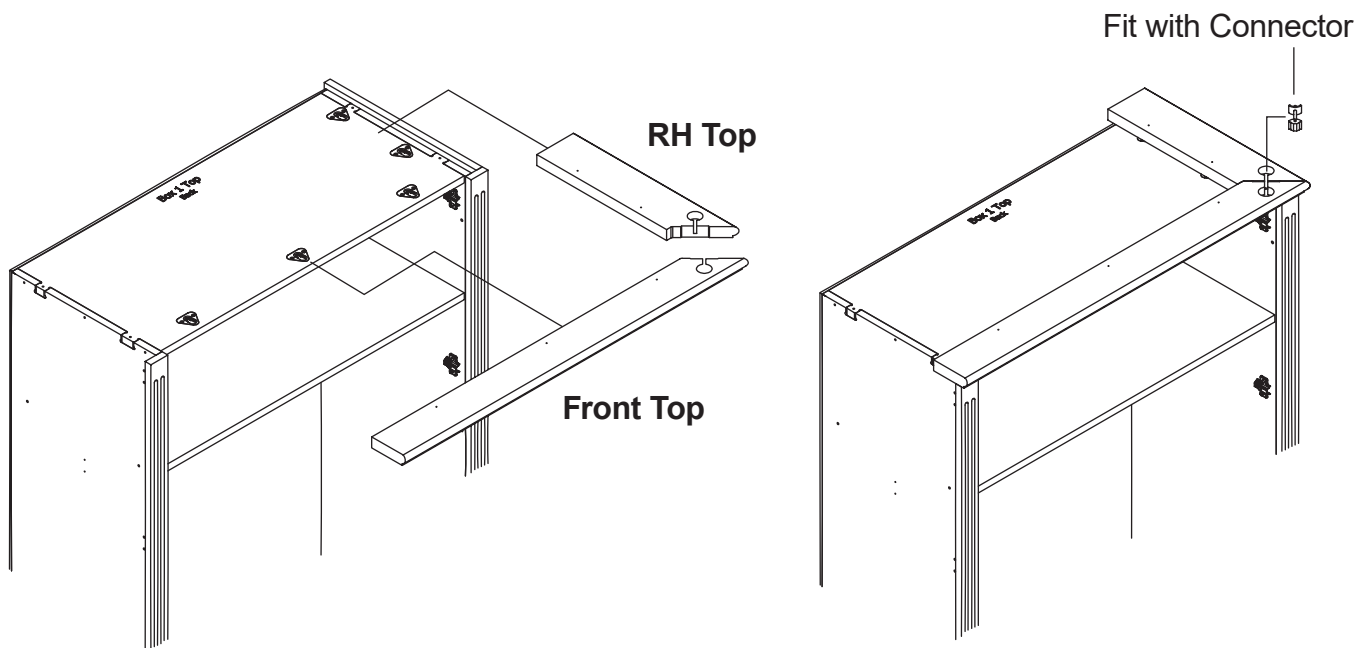

20. The Top may be solid, or formed of several parts. The underside should have Buttons which can be aligned with the triangular fittings on the Box Top. Engage these, then push firmly toward the back of the unit to lock them in place. The Connector is placed across the circular holes and fastened with a Hex / Allen key (included), binding the corners together. In some cases, it may be easier to connect the pieces before locking them into place.

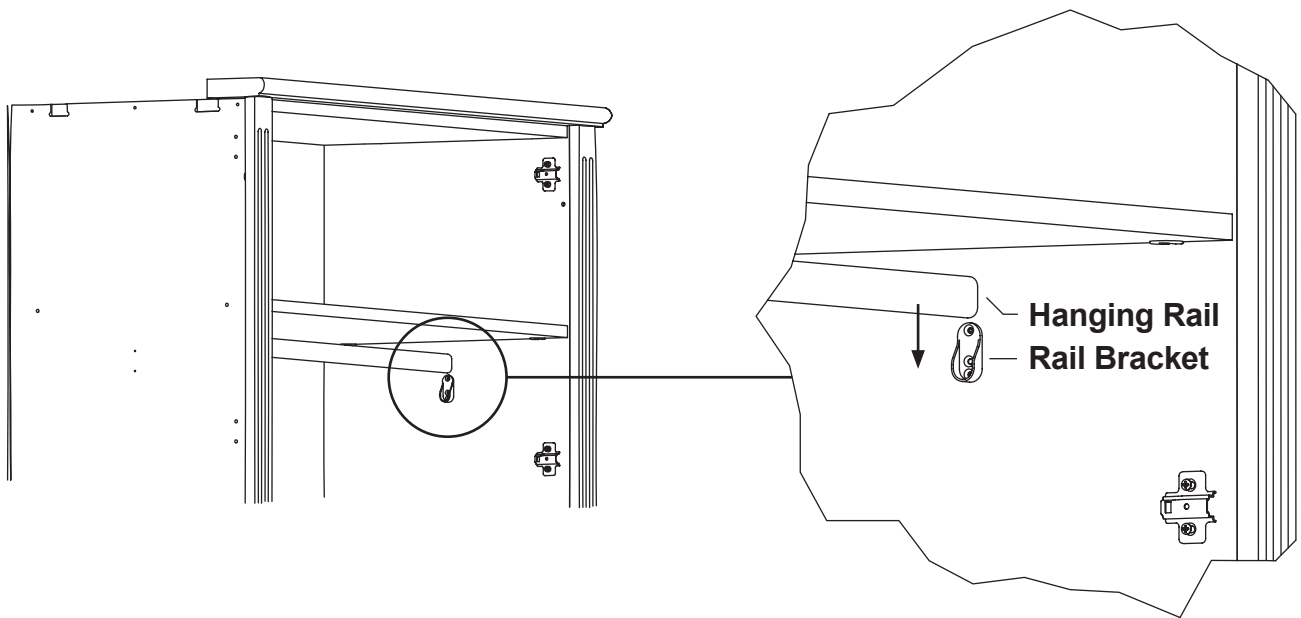

21. If this Wardrobe Box features a Hanging Rail, place it into the Rail Brackets on either side of the Box. You may need to apply reasonable pressure evenly across the width.

---

**If this Wardrobe Box features Drawers, these should be installed now.  
Please consult the Drawer instructions (separate).**

---

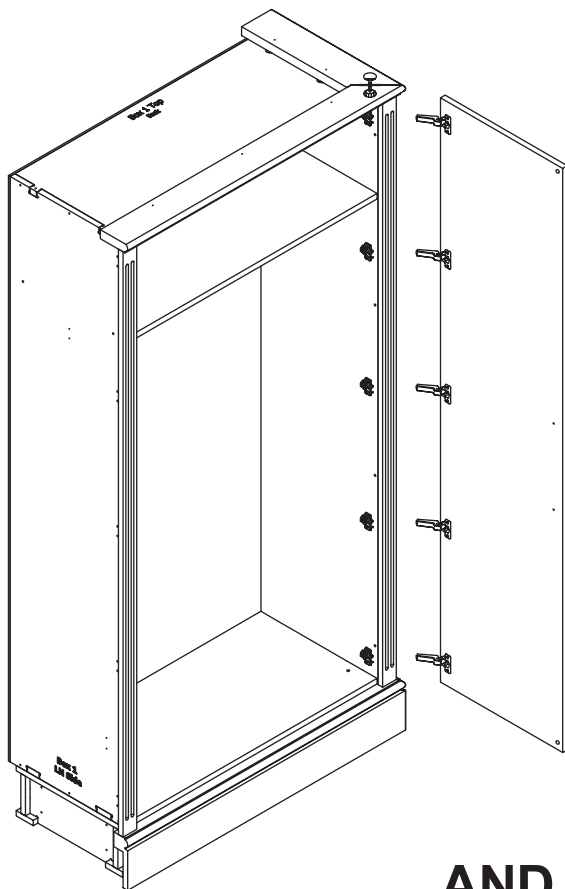

22. This step is easier with two people. Attach the Doors by latching the top and bottom Hinges into their respective Hinge Plates first. Use the Hinge adjusting screws to correct the set of the Door as needed. Then, latch the remaining Hinges to the Hinge Plates.

23. Attach the Door Handles by fastening them to the Bolts through the 4mm holes. Use a screwdriver to tighten.

**AND YOU'RE DONE!**

#jali #wardrobe #makeityours